



 Scala a chiocciola da esterno disponibile con forma tonda;  
Gradini in metallo zincati a caldo per la versione Econ Z o con zincatura galvanica+verniciatura epossidica per la versione Econ Zincolor;  
Palo centrale in metallo;  
Ringhiera con colonne in acciaio inox;  
Corrimano disponibile solo in PVC grigio.

 Spiral staircase for outdoor use available with round shape;  
Metal hot galvanized steps for ECON Z version or galvanized +epoxy painting for ECON ZINCOLOR version;  
Metal central pole;  
Banister with stainless spindles;  
PVC handrail, grey color.

 Escalier en colimaçon pour usage extérieur disponible dans la forme ronde;  
Marches en métal avec traitement galvanisé à chaud dans la Version ECON Z ou avec galvanisation+ époxy vernissage dans la version ECON ZINCOLOR;  
Poteau central en métal ;  
Garde-corps avec colonnes en acier inoxydable ;  
Main courante en PVC gris.

 Spindeltreppe mit rundem Form erhältlich für den Außeneinsatz  
Stufen aus Metall feuerverzinkt für Modell ECON Z oder Verzinkung + Epoxidbeschichtung für Modell ECON ZINCOLOR ;  
Zentrale Metallstange;  
Geländer mit Edelstahlsäulen  
Handlauf aus PVC Grau.

 Escalera de caracol disponible en forma redonda para exteriores;  
Escalones en metal galvanizada en caliente para la versión ECON Z o con revestimiento galvánico + epoxi para la versión ECON ZINCOLOR;  
Poste central de metal;  
Barandilla con columnas de acero inoxidable;  
Pasamanos en PVC gris.

## Dettagli tecnici Technical details - Détails techniques Technische Details - Ficha técnica

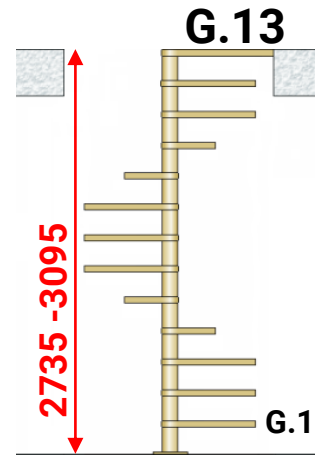
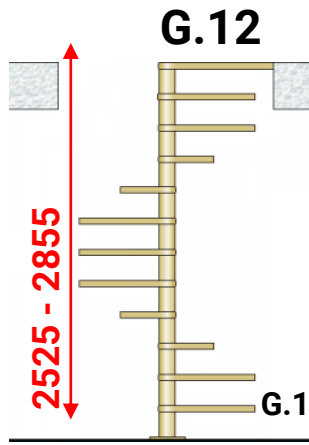
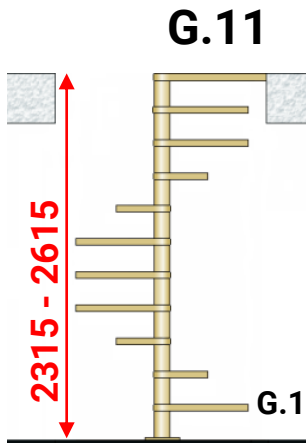

**IMBALLO**  
Dim. 115x97x74 cm  
Peso: circa 190/250 kg.

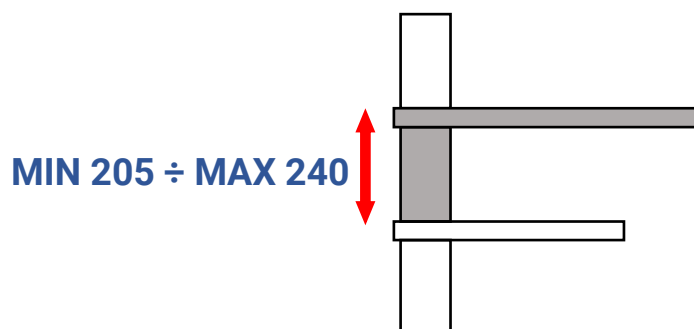
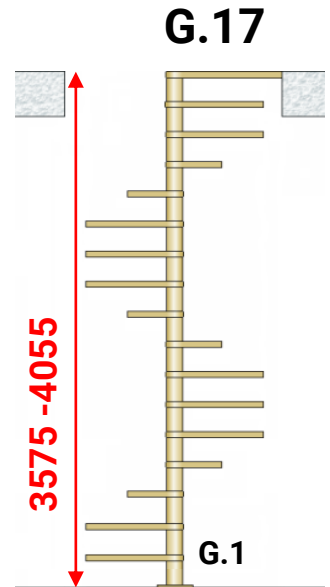
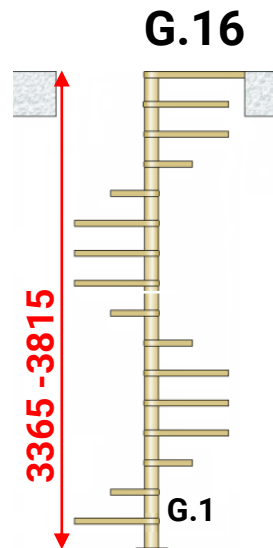
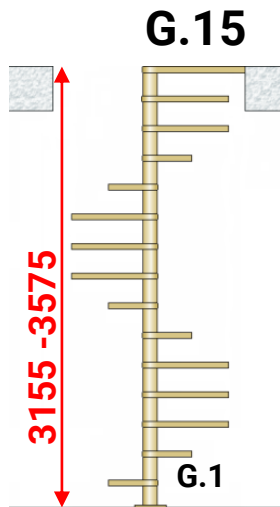
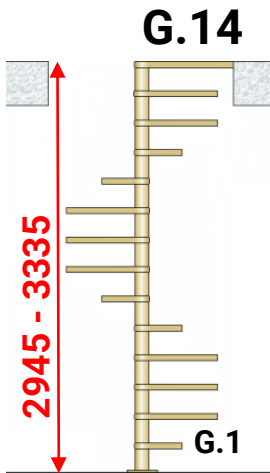

## Dettagli tecnici

### Technical details - Détails techniques

### Technische Details - Ficha técnica

L	C1	C2	C3	P.U.	P.M.
Ø1000	532	609	520	399	129,7
Ø1100	578	660	570	449	142,6
Ø1200	624	711	620	499	155,6
Ø1400	716	813	720	599	163,6
Ø1600	808	915	820	699	187,0

### FORO, WELL, TRÊMIE, LOCH, HUECO

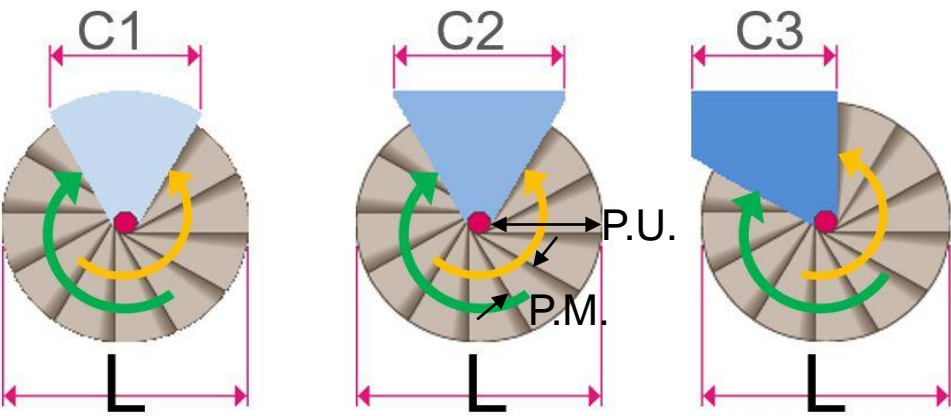
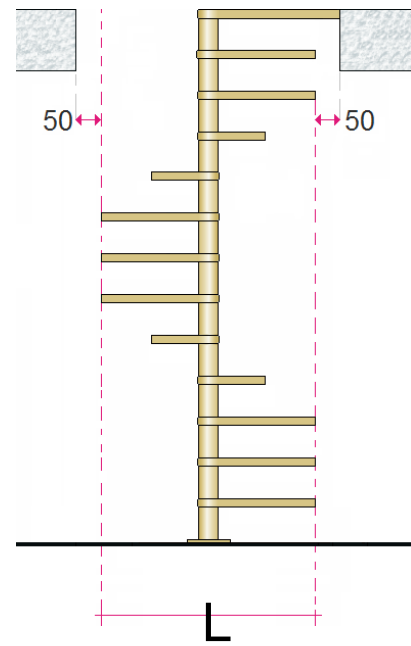

### FISSAGGIO ARRIVO SBARCO, FIXING OF THE ARRIVAL LANDING, FIXATION DU PALIER D'ARRIVÉE, BEFESTIGUNG DES ANKUNFTSPODESTS

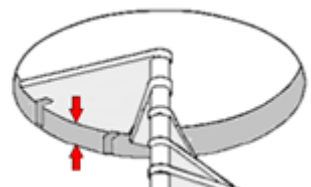

**MIN 210**

### APERTURA GRADINI, TREADS OPENING, OUVERTURE DES MARCHES, ÖFFNUNG DER STUFEN, APERTURA DE LOS ESCALONES

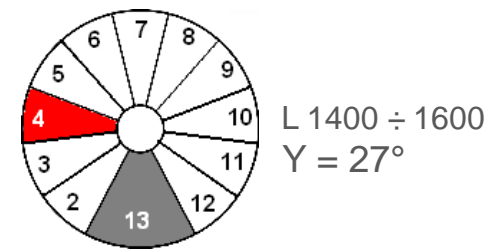
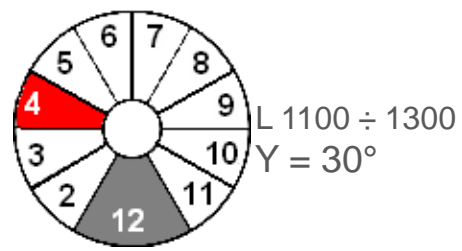

## ECON Z

Ø45 PVC grigio  
grey PVC  
gris PVC  
graus PVC  
PVC gris

## ECON ZINCOLOR

Ø45 PVC grigio  
grey PVC  
gris PVC  
graus PVC  
PVC gris

Ø 22 mm

Ø 22 mm

Zincatura a caldo  
hot-dip galvanized  
galvanisé à chaud  
Feuerverzinkt  
galvanizado en caliente

Zincatura galvanica+  
verniciatura epossidica

Galvanized+epoxy painting

Placage galvanique+  
Peinture époxy

Galvanische Beschichtung+  
Epoxyd-Lackierung

Galvanizado+  
Pintura epoxi

200 Kg/m<sup>2</sup>

200 Kg/m<sup>2</sup>

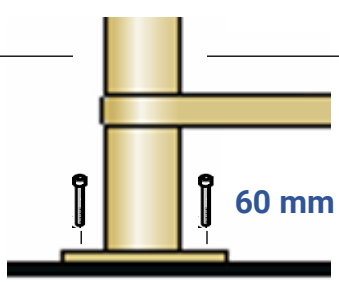

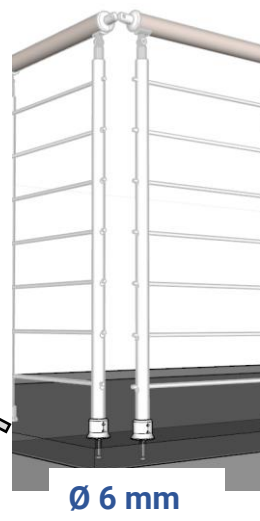
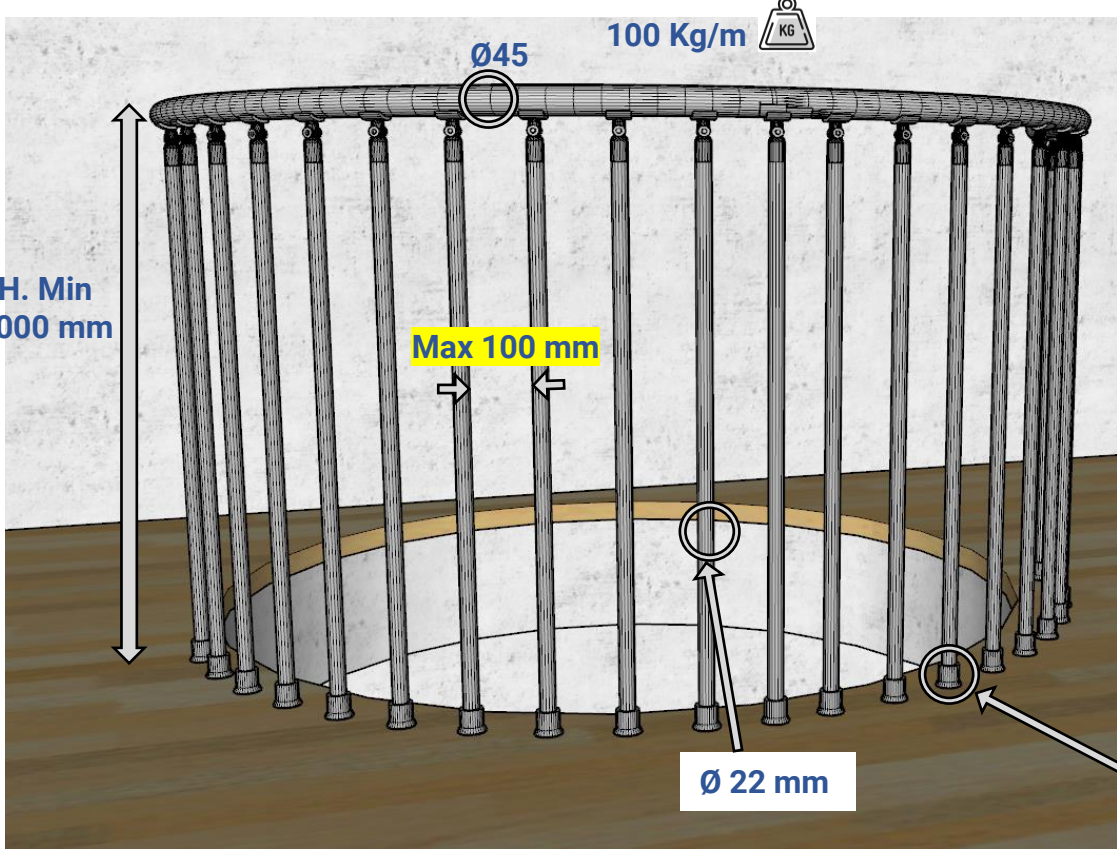
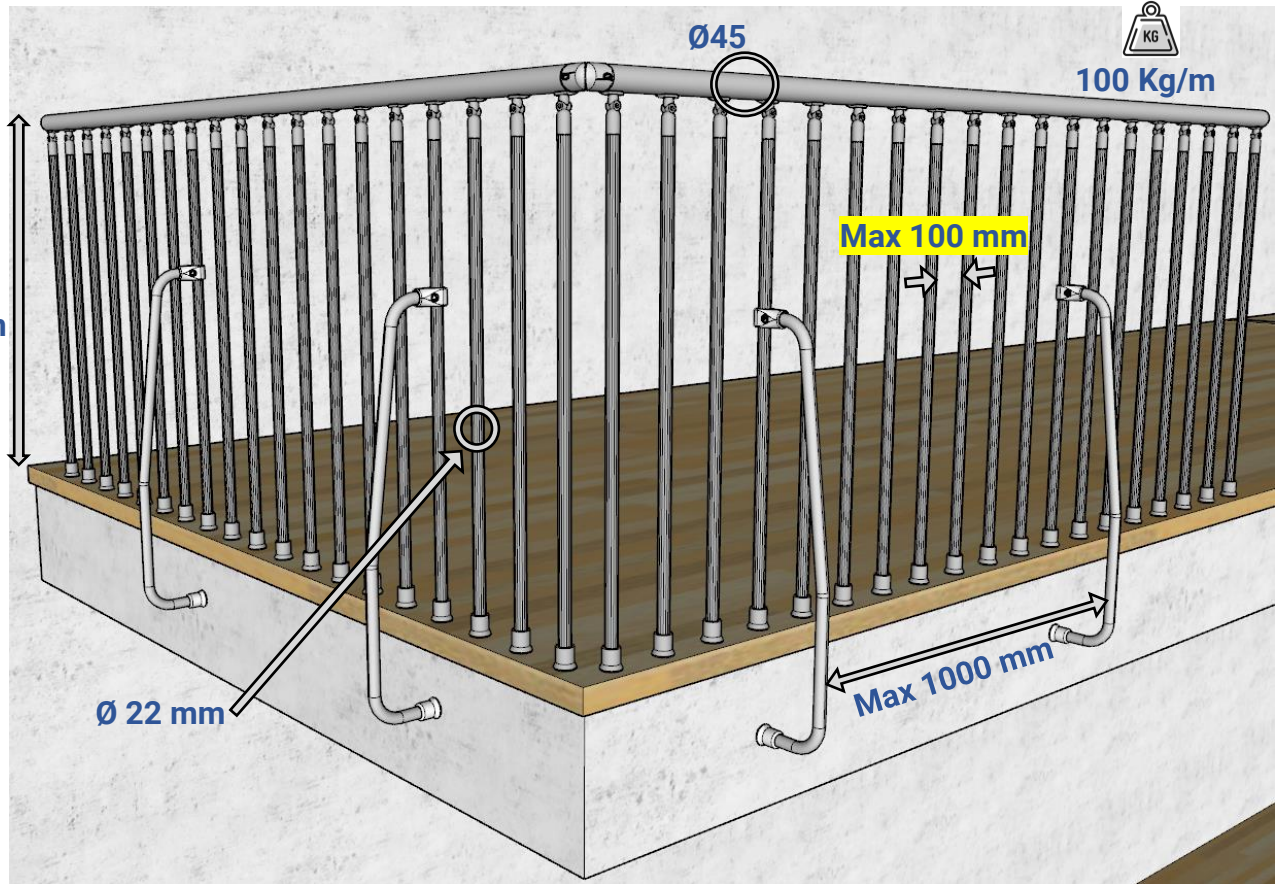

**Sbarco su misura**  
Landing on measure - Palier sur mesure  
Podest nach Maß - Desembarque personalizado

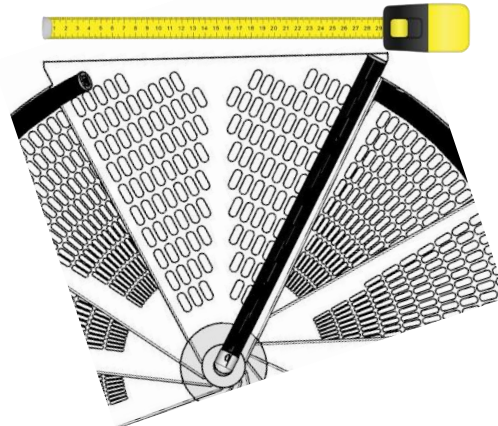

**Scala sovrapposta**  
Overlapping staircase - Escalier superposé,  
überlagerte Treppe - Escalera superpuesta

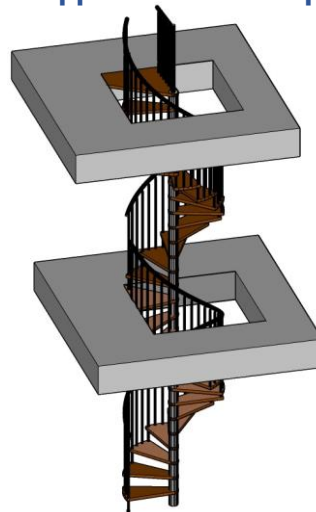

**Pianerottolo tondo**  
Round landing - Palier ronde  
Runde Podest - Desembarco redondo

